



32" CLASS LED HD TV

MODEL NO.: NT-3204



Instruction Manual

PLEASE READ CAREFULLY BEFORE USE

FCC NOTICE

This device complies with Part 15 of the FCC Rules. Operation is subject to the following two conditions: (1) this device may not cause harmful interference, and (2) this device must accept any interference received, including interference that may cause undesired operation.

WARNING: Changes or modifications to this unit not expressly approved by the party responsible for compliance could void the user's authority to operate the equipment.

NOTE: This equipment has been tested and found to comply with the limits for a Class B digital device, pursuant to Part 15 of the FCC Rules. These limits are designed to provide reasonable protection against harmful interference in a residential installation. This equipment generates, uses, and can radiate radio frequency energy and, if not installed and used in accordance with the instructions, may cause harmful interference to radio communications.

However, there is no guarantee that interference will not occur in a particular installation. If this equipment does cause harmful interference to radio or television reception, which can be determined by turning the equipment off and on, the user is encouraged to try to correct the interference by one or more of the following measures:

- Reorient or relocate the receiving antenna.
- Increase the separation between the equipment and receiver.
- Connect the equipment into an outlet on a circuit different from that to which the receiver is connected.
- Consult the dealer or an experienced radio/TV technician for help.

SUPPORT

If you have problems with your device, please consult the instructions in this manual. Please also visit us on the web at www.naxa.com to get up to the minute news, alerts, and documentation for your device. For additional assistance, please contact Naxa Technical Support.

NAXA Technical Support

2320 East 49th St.

Vernon, CA 90058

Tel: (323)-583-8883

http://www.naxa.com/naxa_support/

Made in China

Safety Information

WARNING

To prevent fire and/or electric shock, do not use this plug with an extension cord, receptacle, or other outlet unless the blades can be fully inserted to prevent blade exposure. Do not expose this appliance to rain or moisture.



IMPORTANT SAFETY INSTRUCTIONS

- Read these instructions.
- Keep these instructions.
- Heed all warnings.
- Follow all instructions.
- Please, unplug the TV power cord when the following conditions occur:
 - When there is a thunderstorm (Please, pull out the power cord and antenna).
 - When cleaning the TV set.
 - When the TV set is not used for a long time.
- Do not use corrosive deparative when cleaning the TV set.
- Do not put the TV set under direct sunlight or near heat.
- Do not put a heat source, such as a candle or heater, on top of or near the TV set.
- Leave plenty of space (at least 10 cm) around the TV set for ventilation.
- Place the TV set away from where it can be ruined by rain or water (such as near a window).
- Do not put a container with liquid (such as a vase) on top of the TV set.
- Do not move the TV set when the power is on.
- Do not touch, push, or scratch the surface of the TV set with hard materials or items.
- When TV surfaces are dirty, please use a wet cotton cloth or soft cloth with non-corrosive cleaners to clean it carefully. Do not use acetone, toluene, or alcohol to clean the TV set.
- Be aware and careful of moisture, which can damage inner electronic components.
- When condensed moisture is present, the TV screen may appear blurry or spotty.
- It is recommended that a technician install the TV set on a wall, if such placement is desired.
- An incorrect wall installation will be unsafe and hazardous.
- Do not let children climb on or play around the TV set to avoid falls, collisions, damages, and injuries.
- Do not hit the TV panel with hard objects to prevent damages.
- Do not cover the TV set with blankets or other objects when it is connected to a power source to prevent overheating and fire.
- Batteries shall not be exposed to excessive heat, such as sunshine, fire, or the like.
- Mains plug is used as disconnect device from the mains, the disconnect device shall remain readily operate.
- Apparatus with class 1 construction shall be connected to a mains socket outlet with a protective earthing connection.

Important Safety Precautions

SAFETY

Please, immediately pull out the AC power plug if there is an abnormal sound or smell or the LED TV has sound but no picture, and contact after sales support.

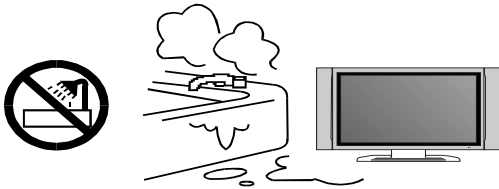

The LED TV should be kept free from rain, moisture and dust to prevent electrical shock and short circuits. Do not cover the ventilation openings with table clothes, curtains, newspapers, etc.

The LED TV should be kept free from high temperature heating sources or direct sunlight. Good ventilation is required. Allow 10 cm between the LED TV and other appliances or built-in cabinet walls.

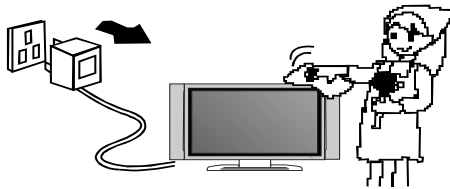
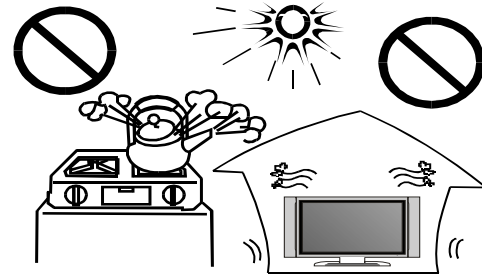

When you wipe the front cabinet, please make sure the power plug is pulled out and use a soft, dry, lint-free cloth and handle it with care. Do not repeatedly wipe the panel, nor scrape, tap, or strike the panel with a hard object.

Do not wipe the LED TV with any petrol, chemical or alcohol based solvents as it will lead to product damage of the panel and cabinet.

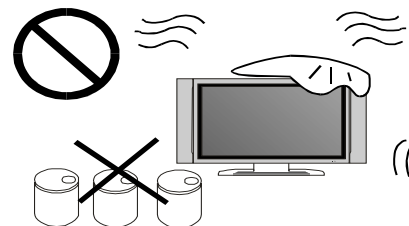

Important Safety Precautions

SAFETY

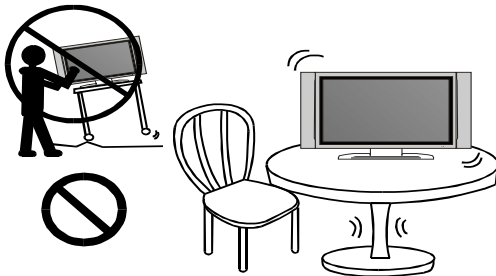

Do not place the LED TV on an unstable surface.

Do not place the power cord or other cables across a walkway in case it is trampled on. Do not overload the power cord or power socket. When the power plug is used to disconnect and connect the device, it should be placed easily into the power source.

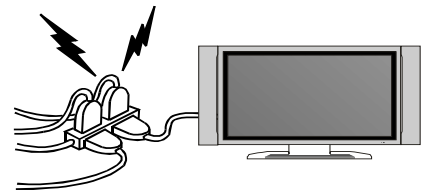

Do not disassemble the back cover, as it contains high voltages inside and will cause electric shock. Only qualified professionals should conduct internal adjustments, maintenance, and checks.

The TV set should not be subjected to water droplets, vapor, or splash. This equipment should not have objects filled with liquids placed on it. Do not place flame sources, such as lit candles, on or near the LED TV. Please, pull out the power plug and contact after sales support if there are abnormal objects or water in the TV.

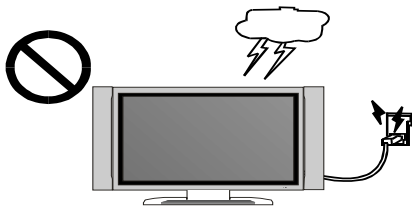
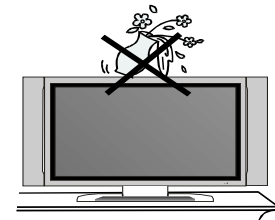

Pull out the power cord and antenna cable during electrical storms so the LED TV is not damaged by electrical surges. Keep all people away from the antenna cable during electrical storms.

Table of Contents

Introduction	7
Features	7
Specifications	8
Accessories	9
General Description	9-12
Overview of Front & Back Panel	9
Overview of Back Panel	10
Overview of Remote Control	11
Installing Batteries in Remote Control	12
Antenna Connection	12
External Connection	13-19
Connecting VCR	13
Connecting DVD Player/Set-Top Box	14
Connecting Digital Audio System	15
Connecting USB	16
Connecting DVD Player/Set-Top Box via HDMI	17
Connecting PC	18
Connecting a Headphone	19
Supporting Signals	19
Basic Operation	20
Turning the TV On and Off	20
OSD Menu Operation	21-28
INPUT SOURCE SELECTION	21
BASIC OPERATION	21
FIRST TIME INSTALLATION	21
PICTURE	22
SOUND	23
TIME	24
SETUP	24-25
LOCK	26
CHANNEL	27
PC SETTINGS	28
USB Operation	28-29
Troubleshooting	30
Picture Defects and the Reason	31

Introduction

Features

- TV adopts TFT LED display screen
- HDTV compatible (480i, 480p, 576i, 576p, 720p, 1080i, 1080p)
- Support American TV Standard 8VSB/Free 64/256QAM, NTSC System, ATSC System
- Connect to computer directly to realize TV/monitor combo
- Zero X radiation complies to green environment protection requirement
- Advanced Chroma Processing
- Closed Captioning/Program Control
- SAP/STEREO/MONO; ATSC
- HDMI Input
- USB Input

Input terminals used for external equipment connection:

Computer VGA/PC Input x 1
AV Input x 1
Antenna Input x 1
YPbPr Input x 1
PC Audio Input x 1
HDMI Input x 3
USB Input x 1

Output terminals used for external equipment connection:

Earphone Output x 1
Coaxial Output x 1
Audio L/R Output x 1

Introduction

Specifications

Display Screen Type	Color Active Matrix LED Display
Model	NT-3204
Maximum Resolution	1366 x 768
Image Control	Fine Digital Control
Power Supply	AC 100-240V ~50/60Hz
TV Receiver System	NTSC System, ATSC System
Frequency Range	Antenna: 2~69, Cable: 2~125
Antenna Input Impedance	75Ohms (Unbalance)
Sound Output	2 x 8W
Power Supply (Remote Control)	DC 3V (Two AAA Batteries)
Power Consumption	60W
Dimensions (LxWxH)	28.8 x 7.7 x 18.7 in.
Weight (Net Weight)	3.6 kg
Operation Environment Temperature	0°C-40°C

NOTE: Design and specification modifications may be made at any time without prior notice; all data and dimensions are approximations.

Accessories

Please make sure that the following items are included with your LED TV. If any of the following items are missing, contact your dealer.



Remote Control & Batteries (AAAx 2)

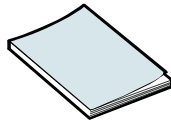

Owner's Instructions



Car charger cable

General Description

Overview of front and back panel

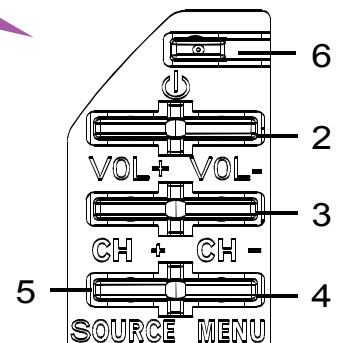
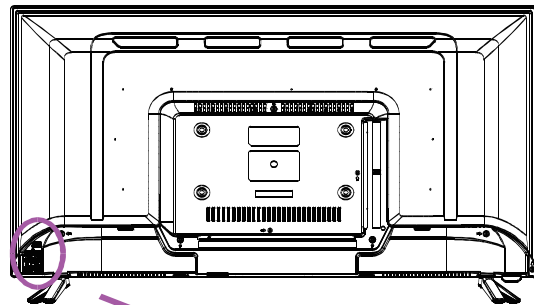
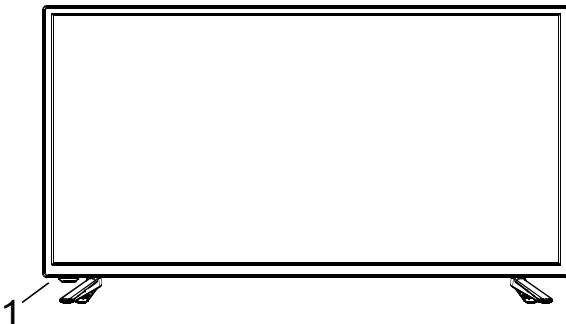

1. Remote control sensor/power indicator.
2. VOL +/-: Press to increase/decrease the volume. In the on-screen menu, use to move left/right.
3. CH +/-: Press to change channels. In the on-screen menu, use to move up/down.
4. MENU: Press to view on-screen menu of your TV.
5. SOURCE: Toggle between all the available input sources.
6. STANDBY: Press to toggle between normal and standby mode.

General Description

Overview of back panel

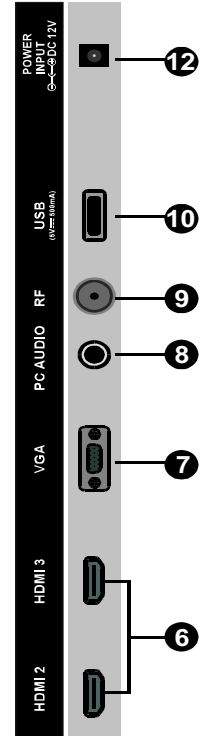
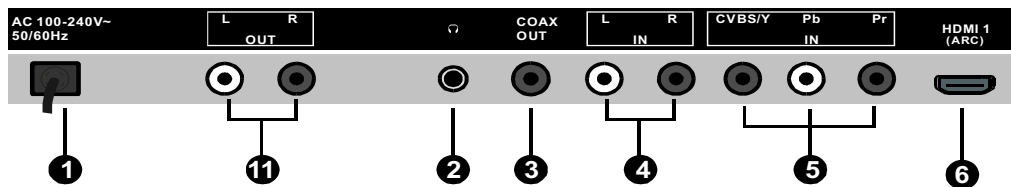
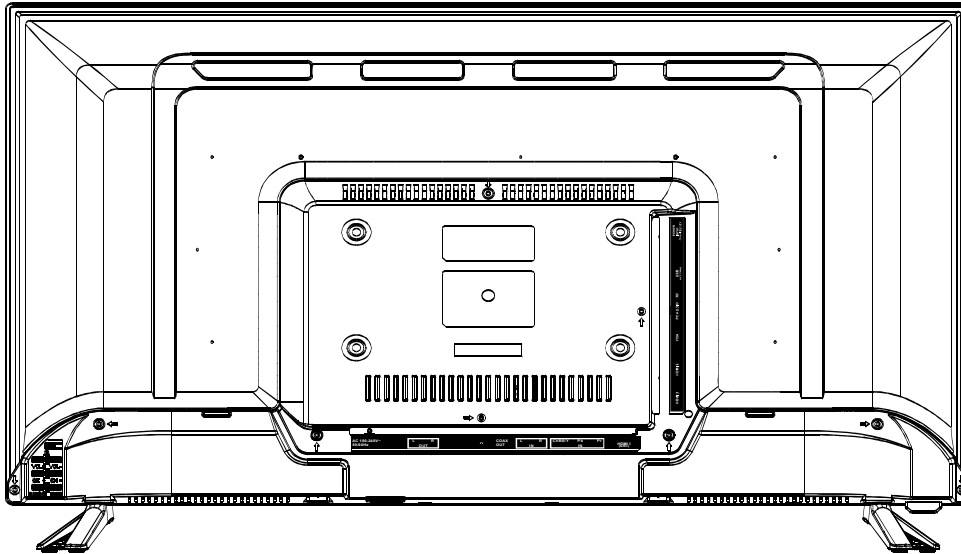

1. Power Input (AC)
2. EARPHONE: Connects to phone for private listening.
3. COAXIAL: Connect to a digital audio device.
4. AUDIO L/R: Audio input for external devices, such as a camcorder or VCR.
5. Y(CVBS)/Pb/Pr: Connect video.
6. HDMI 1/2/3: Connect to the HDMI jack of a device with HDMI output.
7. VGA/PC IN: Connect to the video output jack on your PC.
8. PC AUDIO: Audio input for external devices.
9. ANTENNA INPUT: Connect to an antenna or cable NTSC & ATSC.
10. USB (TV): USB Input
11. Audio L/R Output: Connect to a digital audio device.
12. Power Input (DC)

General Description

Overview of remote control

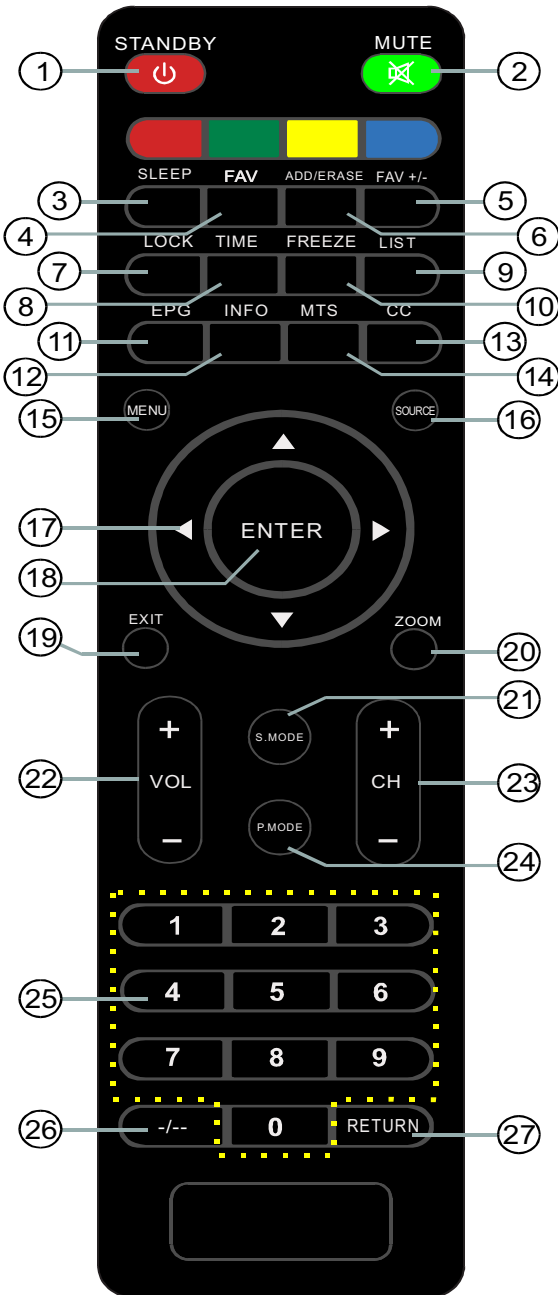

1. STANDBY: Switch LED TV when in standby mode or vice versa.
2. MUTE: Press to mute the sound.
3. SLEEP: Set the sleep timer.
4. FAV: Select favorite channels.
5. FAV +/-: Press to watch next/previous favorite channel.
6. ADD/ERASE: Add current program to the favorite channels list, or erase current program from the favorite channels list.
7. LOCK: Press to display the lock menu.
8. TIME: Press to display current time.
9. LIST: Press to display the TV program list.
10. FREEZE: Press to freeze the screen.
11. EPG: Press to display the EPG menu.
12. INFO: Display the channel information.
13. CC: Press to display the closed caption.
14. MTS: Press to select the audio channels.
15. MENU: TV system setup.
16. SOURCE: Press to change input source.
17. ARROW buttons: Use to move cursor up/down/left/right.
18. ENTER: Validation key.
19. EXIT: Press to exit all menus.
20. ZOOM: Press to change the screen scale.
21. S.MODE: Press to cycle through the different sound settings.
22. VOL +/-: Press to increase/decrease the sound level.
23. CH +/-: Press to scan through channels.
24. P.MODE: Press repeatedly to cycle through the available video picture modes.
25. Number Key (0-9): Press 0-9 to select a TV channel directly when you are watching TV. The channel changes after several seconds.
26. -/--: Press this button to enter a program number for multiple program channel, such as 2-1, etc.
27. RETURN: Return to the previous channel viewed.

General Description

Installing Batteries in the Remote Control

Installing Batteries

1

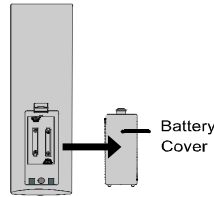

2

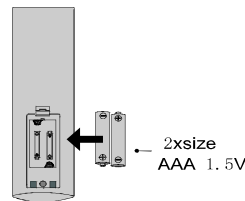

3

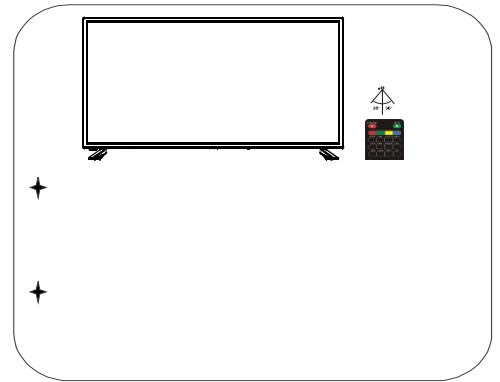
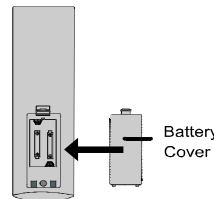

Note:

- One loading of batteries will last for 1 year under normal use.
- If you do not intend to use the remote controller for a long period of time, remove them to avoid damage due to leakage.
- Do not use old and new batteries together.
- The batteries shall not be exposed to excessive heat such as sunshine, fire or the like.

External Connection

Antenna connection

Antenna input impedance of this unit is 75 Ohms. VHF/UHF 75 Ohm coaxial cable can be connected to the antenna jack directly, if the antenna cable is 300 Ohm parallel flat feeder cable, you need to use the 300 Ohm/75 Ohm converter to connect the antenna cable to the antenna jack. For details, please refer to the following drawing:

Antennas with 300 Ohm Flat Twins Leads

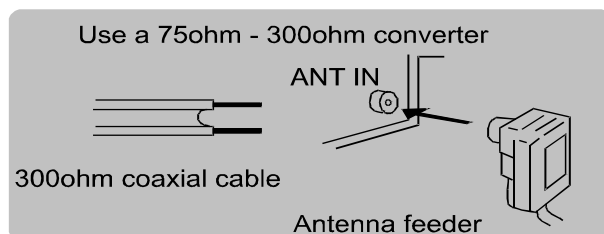

Antennas with 75 Ohm Round Leads

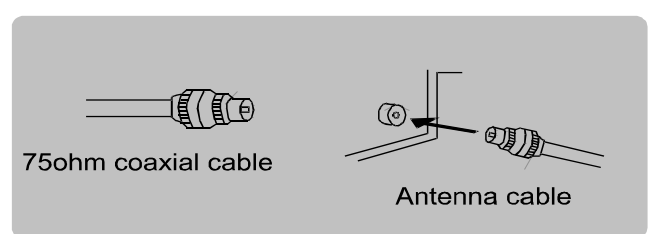

External Connection

Connecting VCR

These instructions assume that you have already connected your TV to an antenna or a cable TV system. Skip step 1 if you have not yet connected to an antenna or a cable system.

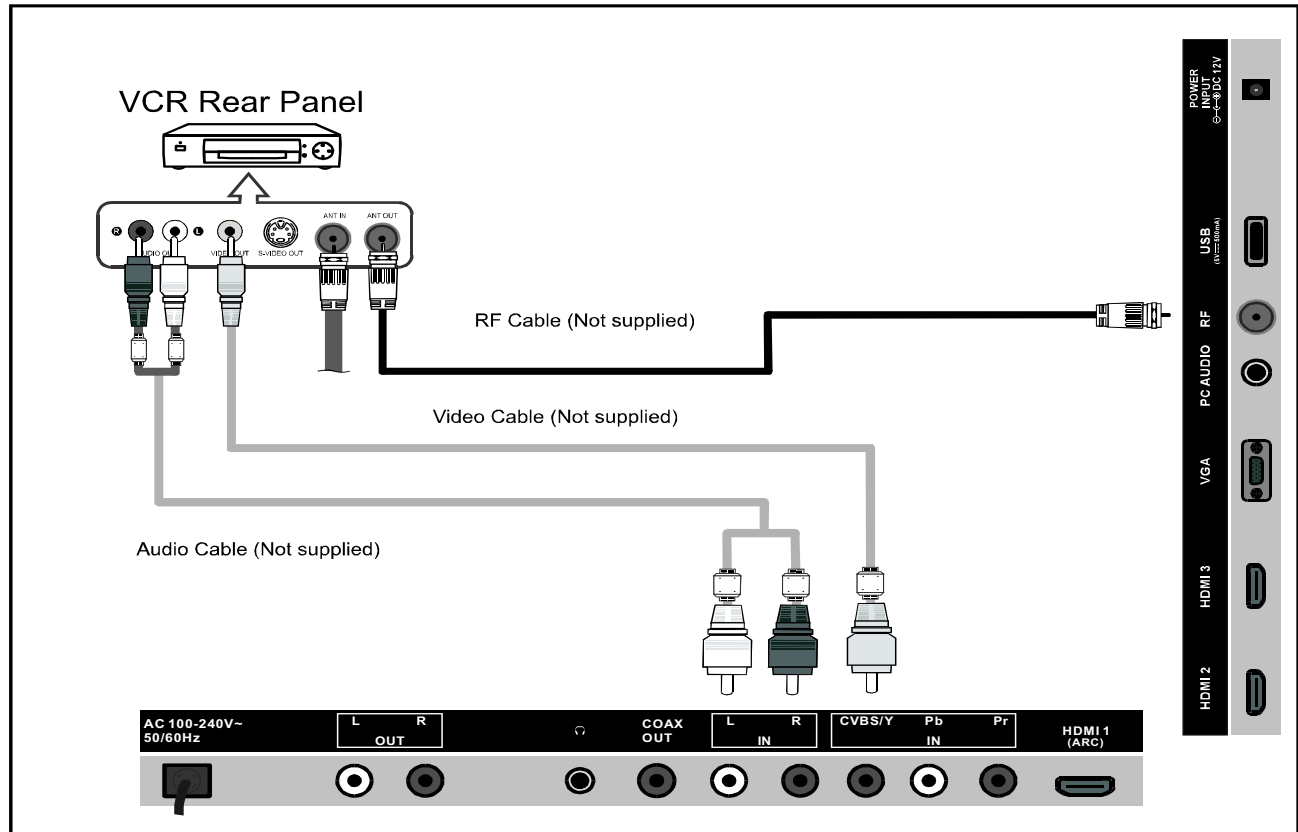

Follow the instructions in Viewing a VCR or Camcorder Tape to view your VCR tape. Each VCR has a different back panel configuration.

When connecting a VCR, match the color of the connection terminal to the cable. We recommend the use of cables with a Ferrite Core.

1. Unplug the cable or antenna from the back of the TV.
2. Connect the cable or antenna to the ANT In terminal on the back of the VCR.
3. Connect an RF cable between the ANT OUT terminal on the VCR and the ANT IN terminal on the TV.
4. Connect a video cable between the VIDEO OUT jack on the VCR and the VIDEO IN jack on the TV.
5. Connect audio cables between the AUDIO OUT jacks on the VCR and the AUDIO L/R jacks on the TV.
 - If you have a mono (non-stereo) VCR, use a Y-connector (not supplied) to hook up to the right and left audio input jacks of the TV. If your VCR is stereo, you must connect two cables.

External Connection

Connecting DVD Player/Set-Top Box

The rear panel jacks on your TV make it easy to connect a DVD player to your TV.

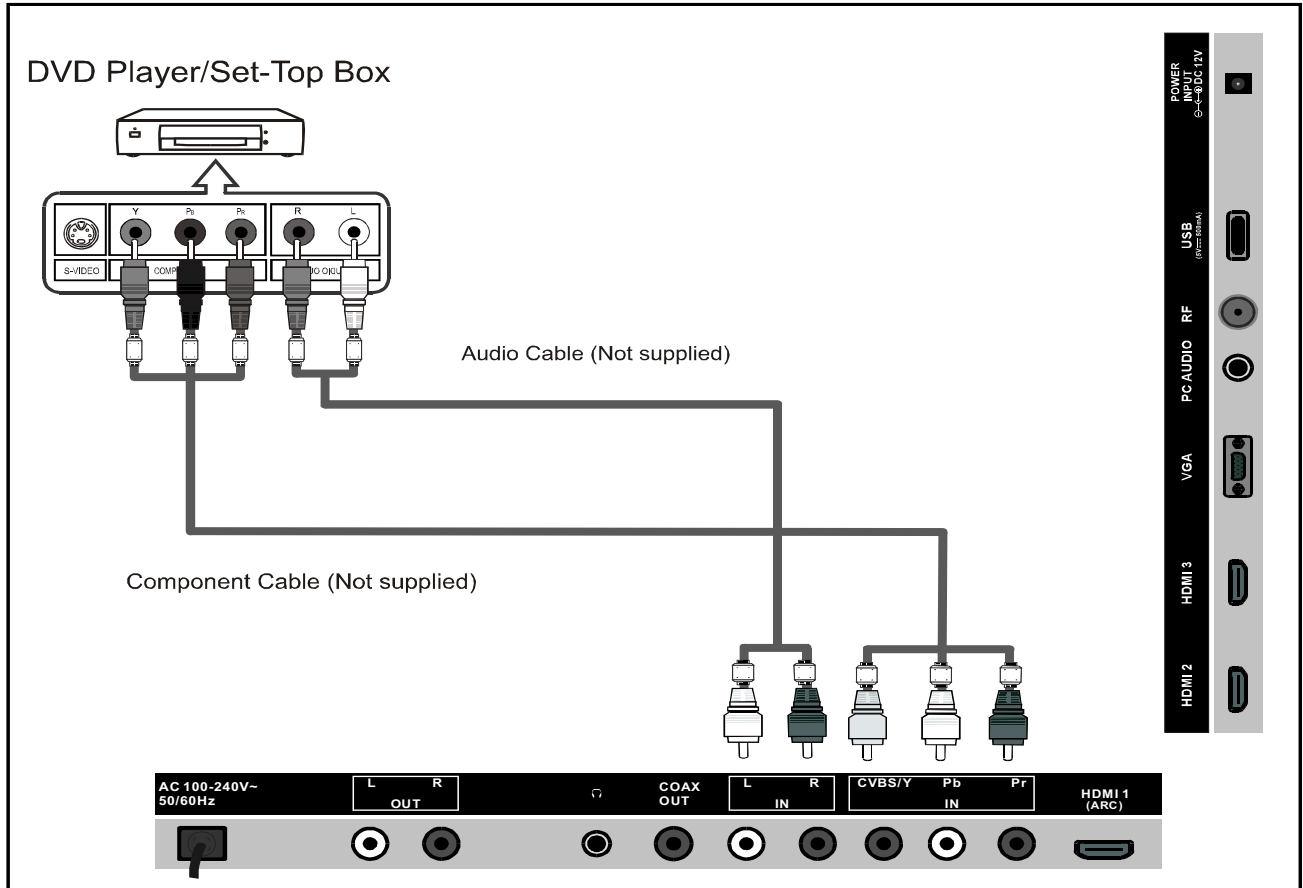

Component video separates the video into Y (Luminance (brightness)), Pb (Blue), and Pr (Red) for enhanced video quality.

Be sure to match the component video and audio connections.

For example, if connecting the video cable to COMPONENT IN, connect the audio cable to COMPONENT IN also.

Each DVD player/STB has a different back panel configuration.

When connecting a DVD player/STB, match the color of the connection terminal to the cable. We recommend the use of cable with a Ferrite Core.

1. Connect a component cable between the COMPONENT IN (Y, PB, PR) jacks on the TV and the COMPONENT (Y, PB, PR) jacks on the DVD player.
2. Connect the audio cables between the COMPONENT IN (AUDIO R/L) jacks on the TV and the AUDIO OUT jacks on the DVD player.

External Connection

Connecting Digital Audio System

The rear panel jacks on your TV make it easy to connect a digital audio system to your TV.

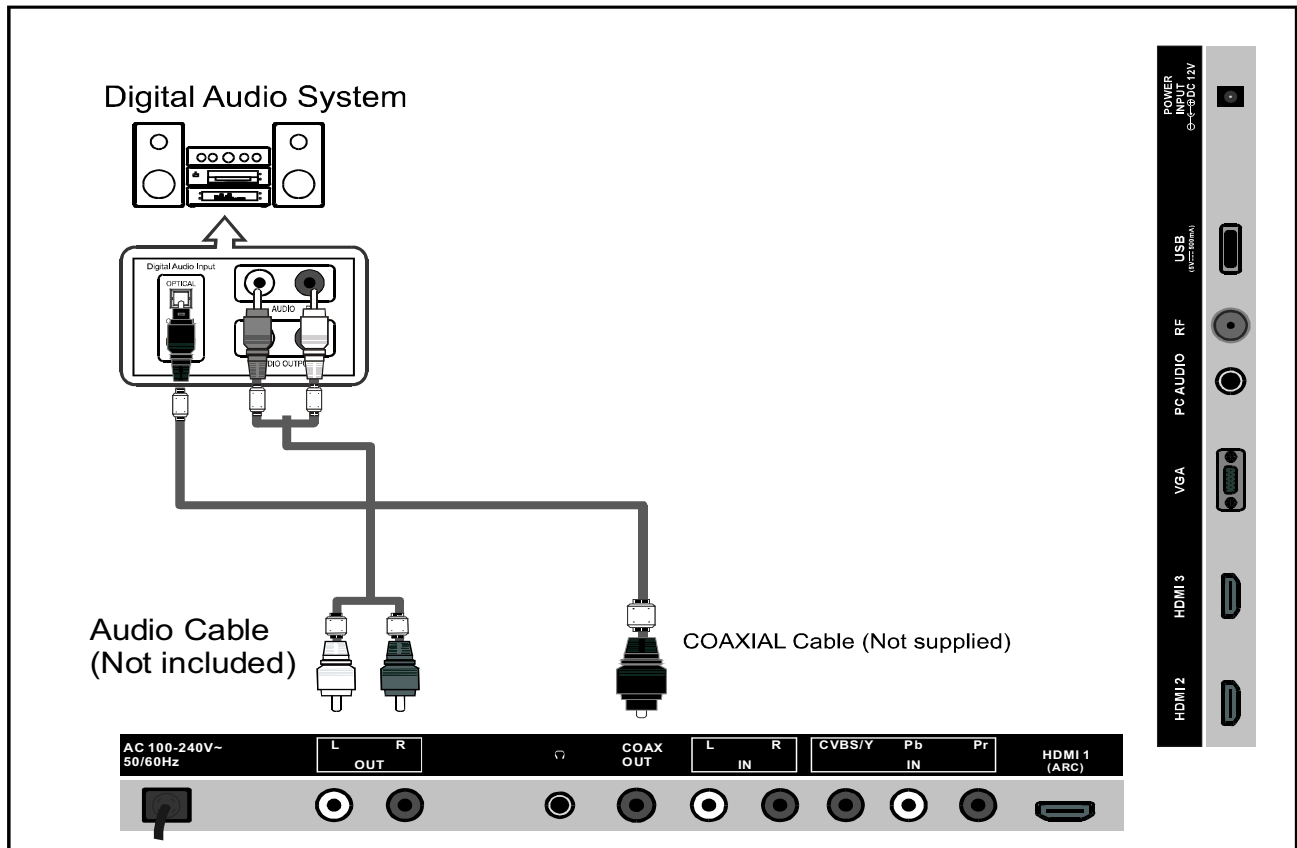

5.1 CH audio is possible when the TV is connected to an external device supporting 5.1 CH. We recommend the use of cables with a Ferrite Core.

1. Connect a coaxial cable between the SPDIF jacks on the TV and the digital audio input jacks on the digital audio system. When a digital audio system is connected to the SPDIF terminal: Decrease the gain (volume) of the TV, and adjust the volume level with the system's volume control.

External Connection

Connecting USB

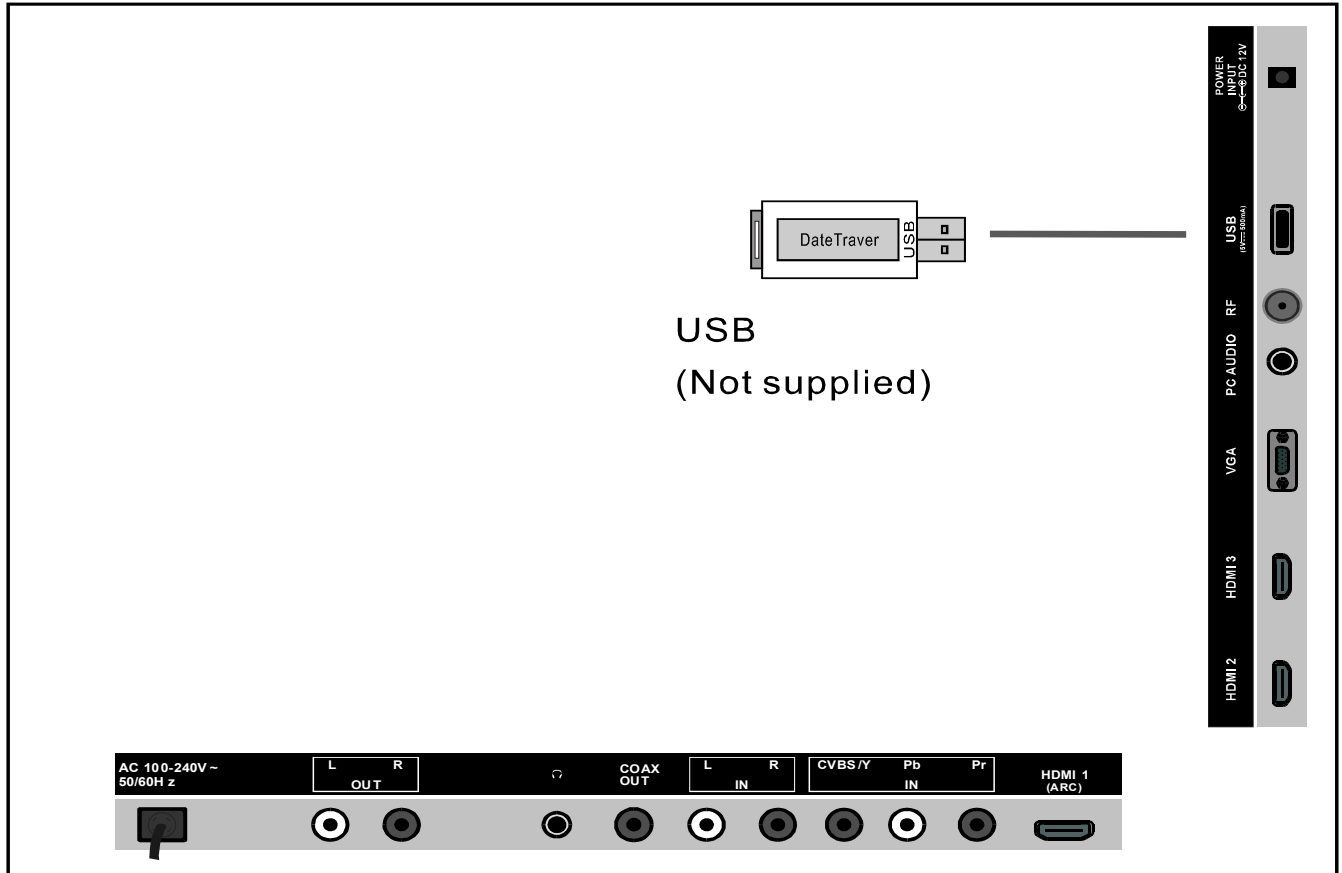

Connect a USB 2.0 memory device into the USB slot of your TV for playback of multimedia files.

1. This USB slot only supports music (MP3) and photo (JPG) multimedia files playback.
2. This TV is compatible with most USB devices on the market. However, we cannot guarantee the compatibility of all USB devices, due to multiple technology standards used.

External Connection

Connecting DVD Player/Set-Top Box via HDMI

This connection can only be made if there is an HDMI output connector on the external device.

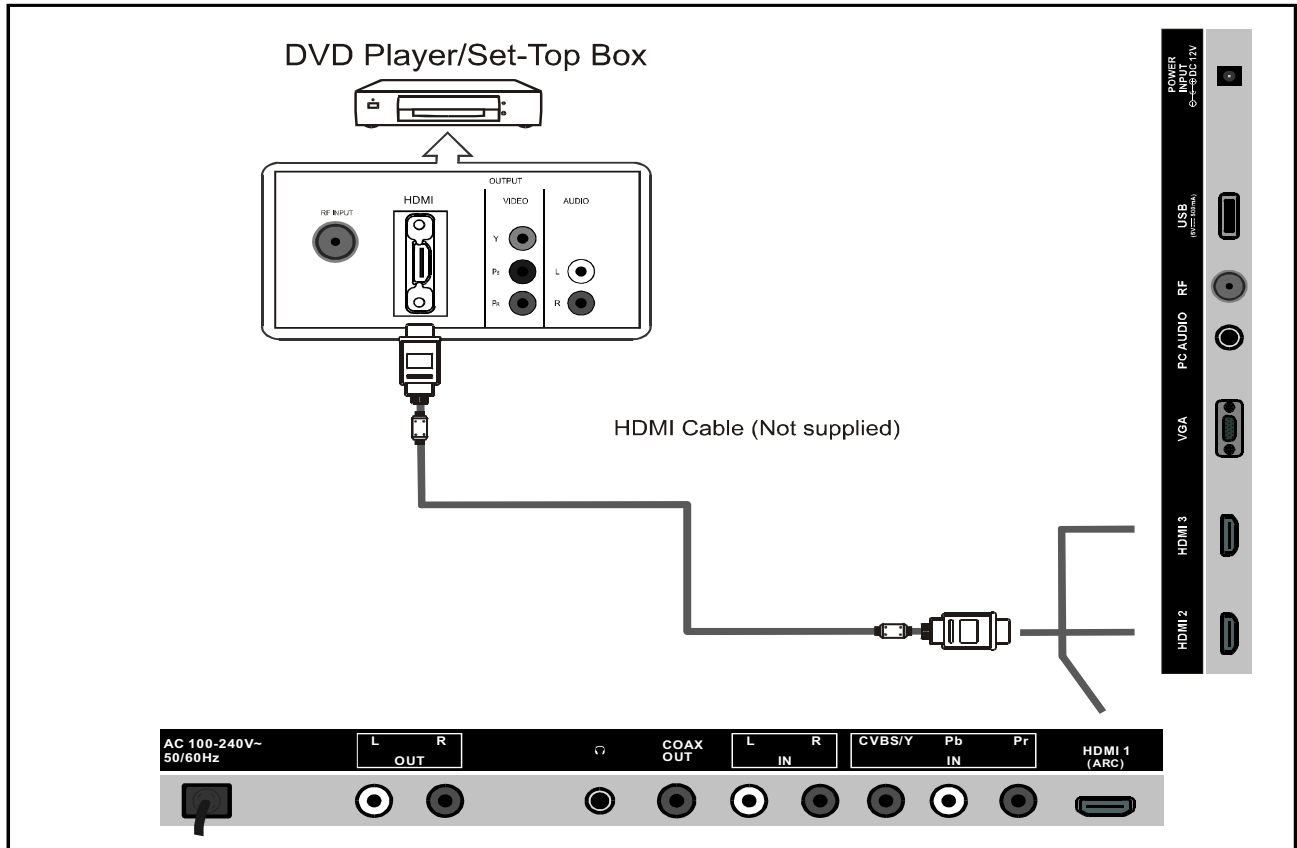

What is HDMI?

HDMI, or high-definition multimedia interface, is a next-generation interface that enables the transmission of digital audio and video signals using a single cable without compression.

Multimedia interface is a more accurate name for it, especially because it allows multiple channels of digital audio (5.1 channels).

The difference between HGMI and DVI is that the HDMI device is smaller in size, has the HDCP (High Bandwidth Digital Cop Protection) coding feature installed, and supports multi-channel digital audio.

Each DVD player/STB has a different back panel configuration.

We recommend the use of cables with a Ferrite Core.

1. Connect an HDMI cable between the HDMI connector on the TV and the HDMI connector on the DVD player/Set-Top Box.

External Connection

Connecting PC

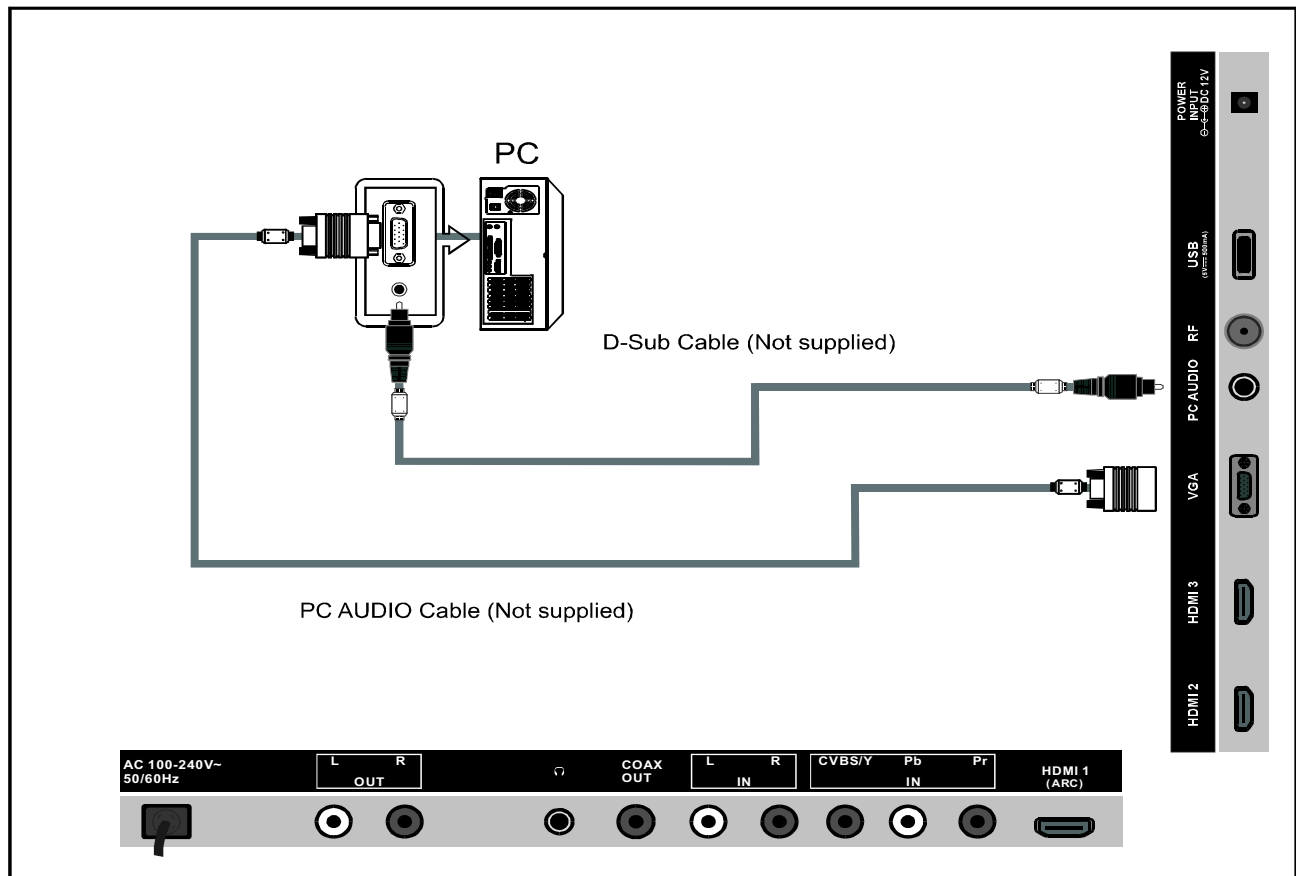

Each PC has a different back panel configuration.

The HDMI jacks do not support PC connection.
We recommend the use of cables with a Ferrite Core.

1. Connect a D-Sub cable between RGB/PC IN connector on the TV and the PC output connector on your computer.
2. Connect the PC audio input jack on the TV.

External Connection

Connecting a Headphone

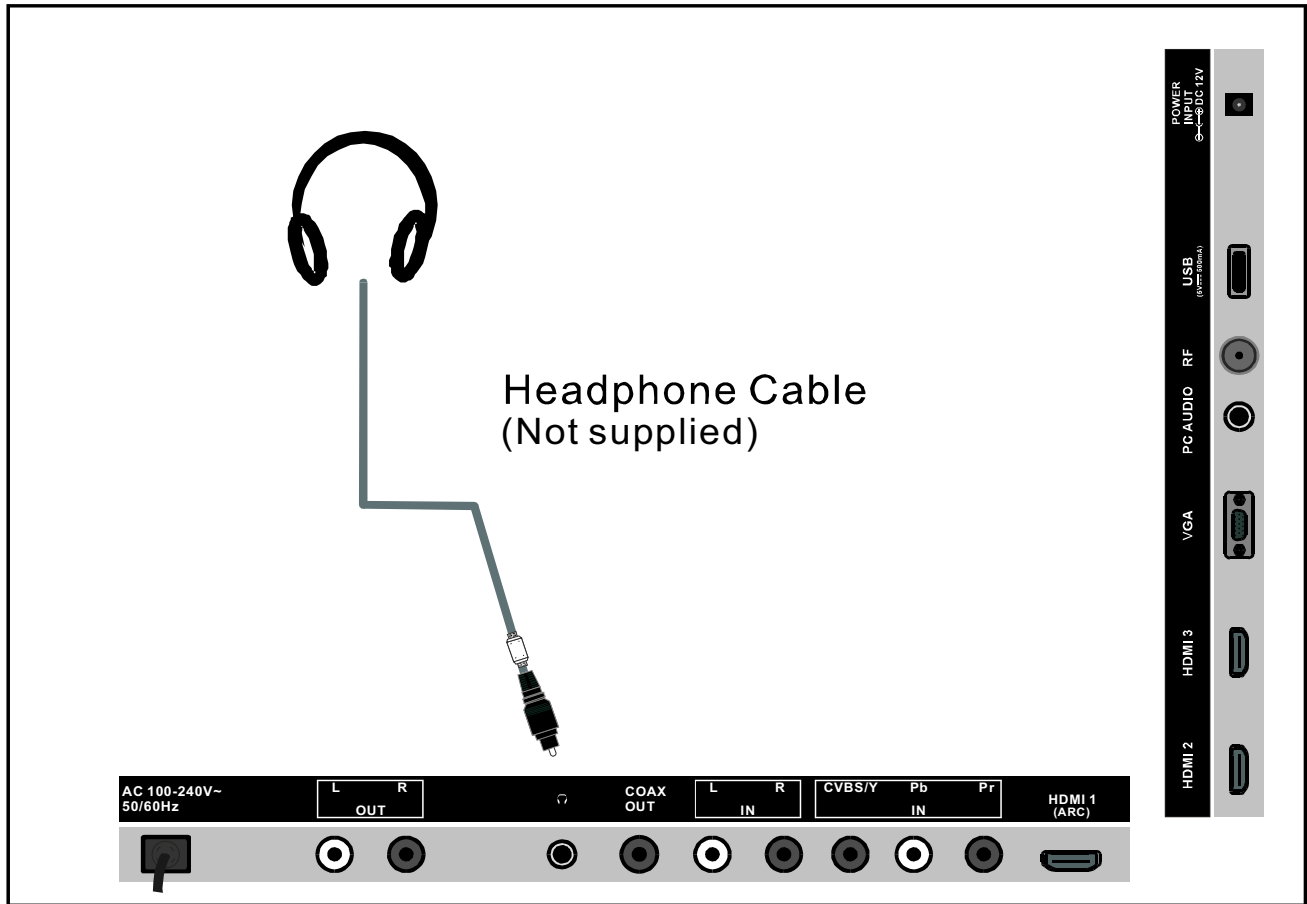

Plug headphone connector into headphone jack on the TV. The TV speaker will be muted.

Supporting signals

VGA/PC	Up to 1366 x 768 @60Hz
COMPONENT	480i, 480p, 576i, 576p, 720p, 1080i, 1080p
HDMI	480i, 480p, 576i, 576p, 720p, 1080i, 1080p

Basic Operation

Turning the TV On and Off

How to Turn the TV On or Off

1. Insert the power cord plug into a polarized AC outlet.
2. Press the power button on the remote control or on the LED TV.
3. Normal picture will be displayed on the screen after 6 seconds. If there is no signal input, "No Signal" will be displayed on the screen.
4. If a temporary power off is required, press the power button on the remote control or on the LED TV.
5. If you want to completely turn off the TV, unplug the power cord for the unit.
6. After turning off the unit, you should turn on the TV again at least 5 seconds later.

Indicator Light Status

Blue: TV is in power on mode

Red: TV is in standby mode

Auto Power Off

If there is no signal input in TV mode, the TV will automatically access the standby mode after 10 minutes.

Memory Before Turning TV Off

The settings of picture and the preset channels will be memorized at turning off the unit. When being started up again, the unit will work according to the mode set before being turned off.

OSD Menu Operations

INPUT SOURCE SELECTION



1. Press the SOURCE button to display the input source list.
2. Use the up and down arrow buttons to select the input source you want to watch.
3. Press the ENTER button to enter the input source.

BASIC OPERATION

- Press the MENU button top of the unit or the remote control to display the main menu.
- Use the left and right arrow buttons to select Picture/Audio/Time/Setup/Lock/Channel.
- Use the down arrow button to enter the submenu page.
- Use the up and down arrow buttons to select the option that you want to adjust.
- Use the left and right arrow buttons to adjust the selected option to your desired value.
- Use the right arrow button or ENTER button to enter the next menu page.
- Press the MENU button to return to the previous menu page.
- Press the EXIT button to exit the menu page.



FIRST TIME INSTALLATION

If this is your first time turning on this TV, Setup Wizard will appear on the screen.

- Use the up and down arrow buttons to select the preferred item.
- Use the left and right arrow buttons to adjust the value.

Menu Language

To choose your menu language.

Air/Cable

To choose your signal type: Air, Cable.

Cable System

To choose your cable system: AUTO, STD, IRC, HRC.

NOTE: Cable system is adjustable only when your signal type is set to cable.

Auto Scan

Highlight Auto Scan, press ENTER to search and store all available channels.



OSD Menu Operations

PICTURE

1. Picture Mode

Available options: User, Standard, Dynamic, Mild.

2. Contrast

The value of contrast can be adjusted from 0-100.

3. Brightness

The value of brightness can be adjusted from 0-100.

4. Color

The value of color can be adjusted from 0-100.

5. Tint

The value of tint can be adjusted from -50 to 50.

NOTE: Tint is adjustable only in certain TV systems.

6. Sharpness

The value of sharpness can be adjusted from 0-100.

NOTE: If the value of contrast, brightness, color, tint, or sharpness has been changed, picture mode will turn to User automatically.

7. Color Temp. (Color Temperature)

Available options: Normal, Warm, Cool.



OSD Menu Operations

AUDIO

1. Sound Mode

Available options: User, Music, Movie, Standard.

2. Bass

The value of bass can be adjusted from 0-100.

3. Treble

The value of treble can be adjusted from 0-100.

4. Balance

The value of balance can be adjusted from -50 to 50.



NOTE: If the value of bass or treble has been changed, the sound mode will turn to User automatically.

5. Surround

This item is used to turn on/off the surround sound function.

6. AVC (Auto Volume Control)

Available options: On, Off.

7. SPDIF Type

This item is used to select preferred SPDIF audio output type.

Available options: Off, RAW, PCM.

8. Audio Language

This item is used to select preferred audio language.

NOTE: This item is adjustable only for digital programs.

9. Accessibility

This item is used to make accessibility for people who are blind or visually impaired.

Voice Guide

Turn on/off voice guide to display the following text on the screen.

Voice Guide: On, Off

Volume: Weak, Middle, Strong

Speed: Weak, Middle, Strong

Pitch: Weak, Middle, Strong

Video Description

Turn on/off video description.

OSD Menu Operations

TIME

1. Sleep Timer

Available options: Off, 5 min, 10 min, 15 min, 30 min, 45 min, 60 min, 90 min, 120 min, 160 min, 240 min.

2. Time Zone

Available options: Eastern, Central, Mountain, Pacific, Alaska, Hawaii, Atlantic.

3. Daylight Saving Time

Available options: On, Off.

NOTE: This item is adjustable only for digital programs.

4. Clock

When an available digital program is present, this unit will get Date and Time information automatically from current program. And it's not user adjustable.



SETUP

1. Menu Language

This item is used to select preferred OSD menu language.

2. Transparency

This item is used to turn on/off transparent OSD menu.

3. Zoom Mode

This item is used to select preferred zoom mode of display screen.

Available options: Normal, Wide, Zoom, Cinema.

NOTE: The available zoom mode may be different for different input sources.

4. Noise Reduction

Available options: Off, Weak, Middle, Strong.

5. Advanced

This item is adjustable only for PC/VGA input signal

6. Closed Caption

CC Mode

Available options: CC on Mute, Off, On.

Basic Selection

Available options: CC1, CC2, CC3, CC4, Text1, Text2, Text3, Txt4



OSD Menu Operations

SETUP

Advanced Selection

Available options: Service1, Service2, Service3, Service4, Service5, Service6.

Option

Mode

Available options: Default, Custom.

Font Style

Available options: Default, Font 0, Font 1, Font 2, Font 3, Font 4, Font 5, Font 6, Font 7.

Font Size

Available options: Default, Normal, Large, Small.

Font Edge Style

Available options: Default, None, Raised, Depressed, Uniform, Left Shadow, Right Shadow.

Font Edge Color

Available options: Default, Black, White, Red, Green, Blue, Yellow, Magenta, Cyan.

FG Color

Available options: Default, White, Red, Green, Blue, Yellow, Magenta, Cyan.

BG Color

Available options: Default, White, Red, Green, Blue, Yellow, Magenta, Cyan.

FG Opacity

Available options: Default, Solid, Flashing, Translucent, Transparent.

BG Opacity

Available options: Default, Solid, Flashing, Translucent, Transparent.

7. DLC

This item is used to turn on/off Dynamic Luminance Control.

8. OverScan (HDMI Mode Only)

Turn on/off OverScan if Users found the image wasn't fully displayed on screen.

9. HDMI CEC

- Press the right arrow button or ENTER button to enter it.

HDMI CEC: Turn on/off HDMI CEC.

Auto Standby: If this function is enabled, connected external CEC device will turn to standby mode automatically after turning off the TV.

Auto TV On: If this function is enabled, the TV will power on automatically after turning on an externally connected CEC device.

HDMI ARC (Audio Return Channel): If this function is enabled, the users can use an external amplifier or audio decoding device that features ARC.

NOTE: "ARC" functions in HDMI1 port only.

Device Control: Turn on/off device control.

Device List: List connected external devices.

10. Restore Default

This item is used to reset to factory default settings.

OSD Menu Operations

LOCK

Input the password by pressing the number buttons on the remote control.

NOTE: The factory default password is "0000".

1. Change Password

- Press the right arrow button or ENTER to enter it.
- Press the number buttons to input the new password and input it again to finish changing the password.

2. System Lock

This item is used to turn on/off system lock.

3. US

TV

- Press the right arrow button or ENTER button to enter it.
- Use the arrow buttons to move the cursor.
- Press the ENTER button to block or unblock it.

MPAA

Available options: N/A, G, PG, PG-13, R, NC-17, X.

4. Canada

Canada English

Available options: E, C, C8+, G, PG, 14+, 18+.

Canada French

Available options: E, G, 8 ans+, 13 ans+, 16 ans+, 18 ans+.

NOTE: US, Canada, RRT Setting and Reset RRT items are adjustable only when system lock is on.

5. RRT Rating

This item is available only when viewing programs which contain related advance rating information.

6. Reset RRT

This item is used to reset RRT rating.

7. Hotel Menu

- Press the right arrow button or ENTER button to enter it.

Hotel Mode: Turn on/off Hotel Mode.

Boot Setting: Set Picture Mode, Default, Volume, Max Volume, Boot Source. (Boot Channel and Channel Select won't work if no TV signals.)

Hotel Lock: Turn on/off Tuner Lock, Keypad Lock, or Menu Lock.

Power Save: Select desired power saver time.

TV to USB: Export data to USB device.

USB to TV: Import data from USB device.

Reset Hotel Setting: Reset above hotel setting.



OSD Menu Operations

CHANNEL

1. Air/Cable

This item is used to select preferred signal receiving type.

2. Auto Scan

Press the right arrow button or ENTER button to enter it.

2.1 Cable System

This item is used to select preferred cable system.

Available options: AUTO, STD, IRC, HRC.

NOTE: This item is adjustable only when your signal type is set to cable.



2.2 Start to Scan

- Press the right arrow button or ENTER button to begin auto scanning.

- Press the MENU or EXIT button to exit auto channel search.

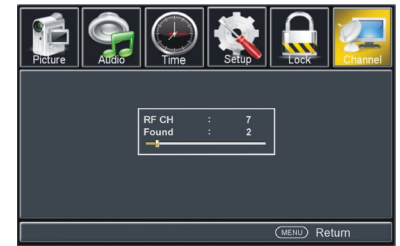

3. Favorite

- Press the right arrow button or ENTER button to enter it.

- Use the up and down arrow buttons to select the preferred channel.

- Press ENTER button to label the selected channel as a favorite or not.

4. Show/Hide

- Press the right arrow button or ENTER button to enter it.

- Use the up and down arrow buttons to select the preferred channel.

- Press ENTER button to show or hide the selected channel.

5. Channel No.

- Press the right or left arrow button to select the preferred channel number.

6. Channel Label

- Press the right arrow button or ENTER button to enter it.

- Use the left or right arrow button to move the cursor.

- Press up or down arrow button to adjust the value.

NOTE: If no available channel is present, Favorite, Show/Hide, Channel No., and Channel Label will not be adjustable

7. DTV Signal

This item is not user adjustable.

OSD Menu Operations

PC SETTINGS

- Press the SOURCE button on top of the unit or remote control to set the unit to VGA mode.
- Press the MENU button to display the main menu and select Setup Item. Then press the down arrow button to enter the setup menu page.
- Press the up or down arrow button to select Advanced and press the right arrow button or ENTER button to enter it.

1. H-Pos (Horizontal Position)

Available range: 0-100.

2. V-Pos (Vertical Position)

Available range: 0-100.

3. Clock

Available range: 0-100.

4. Phase

Available range: 0-100.

5. Auto

If this item is entered, it will adjust the PC screen automatically.



USB

USB Operation

- Before following operations, insert a USB memory device first, which contains photo and music files.
- Press the SOURCE button on top of the unit or remote control to set the unit to USB mode.

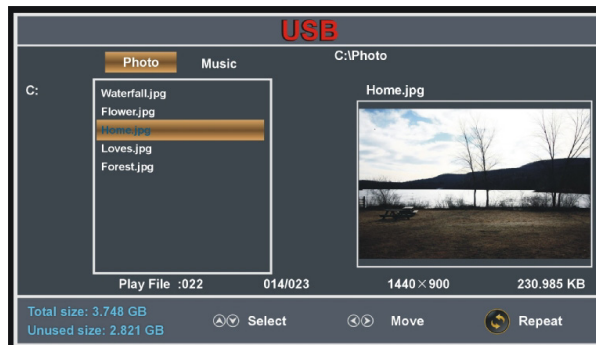

- Use the left and right arrow buttons to select photo/music in the main menu.
- Use the up and down arrow buttons to select the preferred file.

OSD Menu Operations

USB Operation

Photo Playback

- Select Photo Item in the main menu.
- Use the up and down arrow buttons to select the preferred folder/file and press the ENTER button to enter a folder or play the selected file.

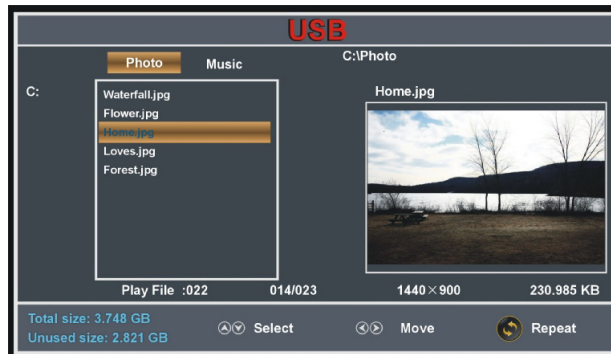

During normal playback:

- Use the up and down arrow buttons to play the previous/next photo.
- Use the left and right arrow buttons to rotate a photo counterclockwise/clockwise.
- Press the EXIT button to return to the file selecting page.

Photo Playback

- Select Music Item in the main menu.
- Use the up and down arrow buttons to select the preferred folder/file and press the ENTER button to enter a folder or play the selected file.



During normal playback:

- Press the INFO button to display/hide the tool bar.



- Use the left and right arrow buttons to select the preferred option and press the ENTER button to confirm it.

Troubleshooting

If you have any problem, check the countermeasures for each symptom listed below. The following symptoms may have been caused by incorrect adjustment rather than actual malfunction of the unit. If the trouble persists, contact the service center.

Symptoms	Possible solutions
No power	Please check the power cord is plugged in. Unplug the power cord and plug it after 60 seconds and restart the TV.
No picture	Please check antenna connection. Station may experience problems, please tune to another station. Please adjust the settings of contrast and brightness.
Good picture but no sound	Please increase the volume. Please check TV is under mute mode, press MUTE button on the remote control. Please check sound settings.
Good sound but abnormal color or no picture	Please check the antenna connection.
No remote control	Batteries of remote control may have been exhausted, if necessary, please change the batteries. Clean the remote control lens. The distance between LED TV and remote control should be within 8m.
Full screen flickering under VGA	V-HEIGHT value may be set too big, restart computer and enter safe mode, then set monitor parameters to correct value according to adjustment description.
Horizontal stripes under VGA	Sample phase may be deflected, adjust phase according to picture position.
Colored dots may be present on the screen	This product is the high resolution LED display device and a few cell defects can occur in the manufacture of the LED. Several colored dots visible on the screen would be acceptable. in line with other LED manufacturers and would not mean that the LED is faulty. We hope you will understand that it could not be changed or refunded.

Picture defects and the reason



Snowy Picture

Snowy picture is usually due to weak signal. Adjust antenna or install an antenna amplifier.



Double Image or Ghosts

Double images are usually caused by reflections from tall buildings. Adjust the direction of the antenna or raise it.



Radio Wave Interference

Wave patterns are moving on the screen, which are usually caused by nearby radio transmitters or short-wave receiving equipment.



High Temperature Electrothermal Interference

Diagonal or herringbone patterns appear on the screen or part of picture is missing. This is probably caused by high temperature electrothermal equipment in a nearby hospital.